

5 62 111 0

Basis Floor trampoline Jump Circle S Ø 170 cm







made in germany

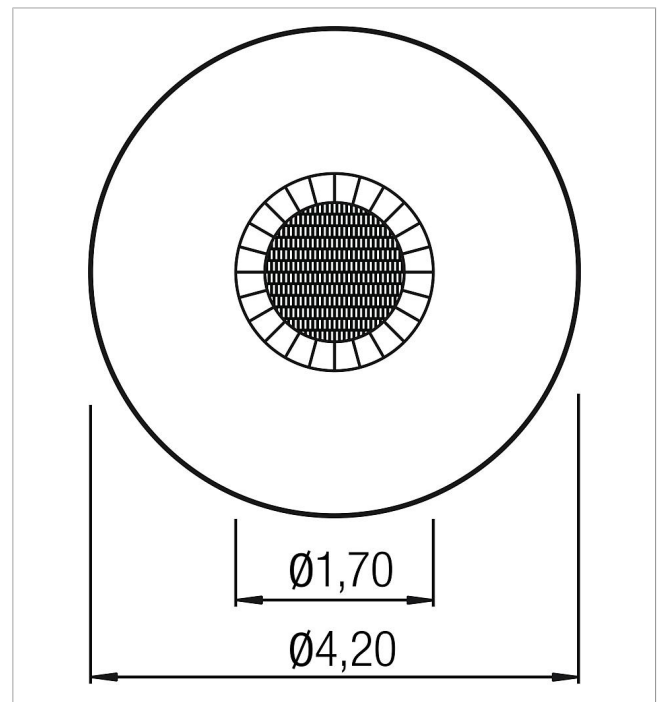

Scope of delivery

- 1x frame profile: galvanised steel
- 1x jumping mat Ø 120 cm: plastic lamellas
- 1x frame cover: rubber granulate
- 60x spring: galvanised steel



	Material	Steel galv., plastic, rubber granulate
	Minimum space	Ø 4,20x1,00 m
	Free falling height	≤100 cm
	Impact protection net	12,0 m ²
	Foundations	-
	Largest section	170x40 cm
	Heaviest section	280 kg