

Age indication



Fitness



Balance



Social skills



Senses





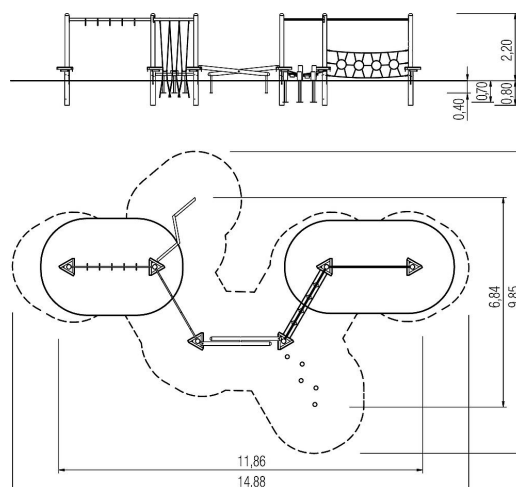

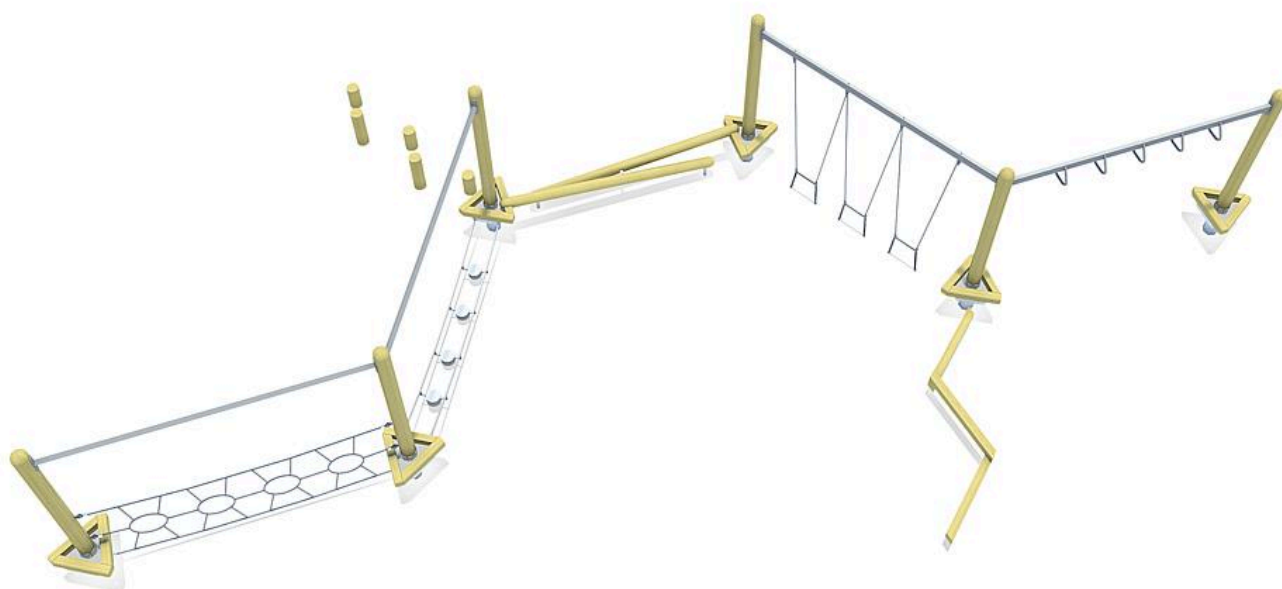

Scope of delivery

- 6x island post: softwood
- 6x post shoe: galvanised steel
- 1x transition L1 palisade path: softwood
- 1x transition L2 zigzag beam: softwood
- 1x transition L6 honeycomb net with rope handrail: plastic coated steel cable
- 1x transition M4 chain of poles with rope handrail: stainless steel, plastic coated steel cable
- 1x transition M6 beam wave: softwood
- 1x transition S4 liana path: plastic coated steel cable, stainless steel
- 1x transition S5 horizontal ladder: stainless steel















Technical data

	Material	SW pi
	Minimum space	9,85x14,88x2,79 m
	Impact protection net	27,0 m ²
	Free falling height	99 cm
	Ground constitution GE/NL/B	at least lawn
	Ground constitution all except GE/NL/B	at least lawn
	Heaviest section	80 kg
	mx. number of users	67
	Certificate	Z2_010651_0528_Rev00
	Tested according to standard	EN 1176 - 1/7
	Service interval (in months)	1

Installation information

	Foundations	11x CF + 8x PFs or 21x CF
	Fundamentlevel	ET 400/700/800
	Assembly	2 persons/12 h
	PF Accessories	8x 5632540
	PF drainage	0,23 m ³
	PF concrete	0,84 m ³
	PF excavation	3,82 m ³
	CF Accessories	10x 5631120
	CF drainage	0,23 m ³
	CF concrete	1,32 m ³
	CF excavation	3,11 m ³



5 25 046 011 00
combination 07



CO₂ emissions of the product

1824,2 kg

Material share of renewable raw materials

46%

Recyclate content

49%

Circularity score

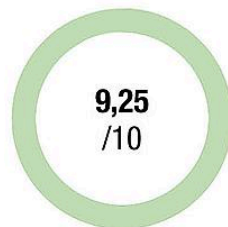

Weighted emission factor of the product*



Disclaimer:

This dashboard for the circularity index of the 'Circular Product' certification was generated automatically and is based on the corresponding certification of eibe Produktion + Vertrieb GmbH & Co KG, Industriestraße 1, 97285 Röttingen, which was issued on 16 May 2024 by the Gesellschaft für Klimaschutz München GmbH (GKM GmbH) on the basis of the example product Albion play unit from the eibe unique® product line. eibe Produktion + Vertrieb GmbH & Co KG is liable for the accuracy of the contents. The award criteria of the private-law certification 'Circular Product' of GKM GmbH can be viewed at gesellschaft-klimaschutz.de/zertifizierung/zirkularitaet/.

* The CO₂e emissions of the materials used in the product are taken into account. The emissions that arise during the production process are allocated to the product on a pro-rata basis.

created on: 14 August 2024