

5 59 835 011 00

minimondo play unit Cherry







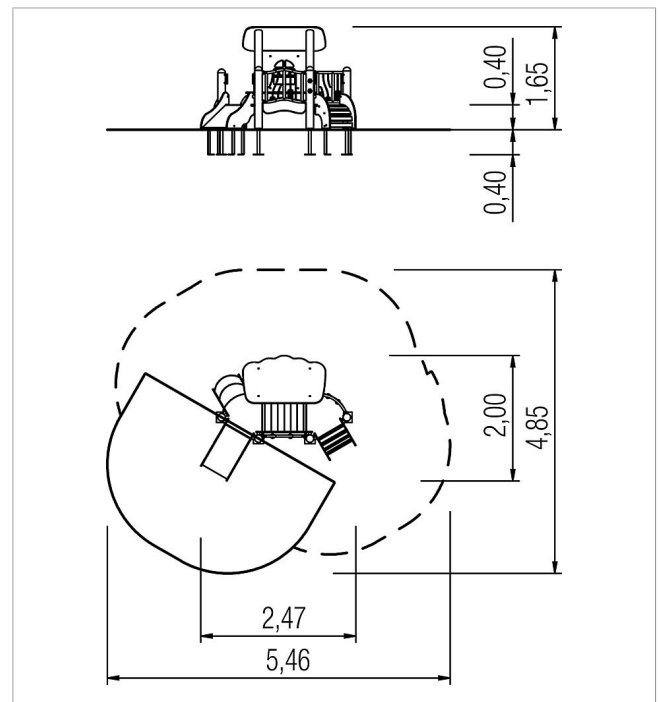

made in germany



Scope of delivery

- 1x roof: high-pressure laminate (HPL)
- 1x bench: high-pressure laminate (HPL)
- 1x wall element with window and shutters: high-pressure laminate (HPL), stainless steel
- 1x belly board: high-pressure laminate (HPL)
- 1x arched ramp: softwood, high-pressure laminate (HPL)
- 1x staircase: high-pressure laminate (HPL)
- 2x platform: high-pressure laminate (HPL), softwood
- 2x fence elements: stainless steel, PE
- 1x set posts with post bases: softwood, galvanised steel



	Material	SW pi
	Foundation level	ET 400
	Minimum space	5,46x4,85x2,20 m
	Free falling height	40 cm
	Impact protection net	7,5 m ²
	Foundations	11x CF or 3x PFs + 8x PFr
	Assembly	2 persons/3 h
	Largest section	132x88x1,5 cm
	Heaviest section	23 kg