

5 56 085 0

## Basis Carousel Oberon Ø 1,10,







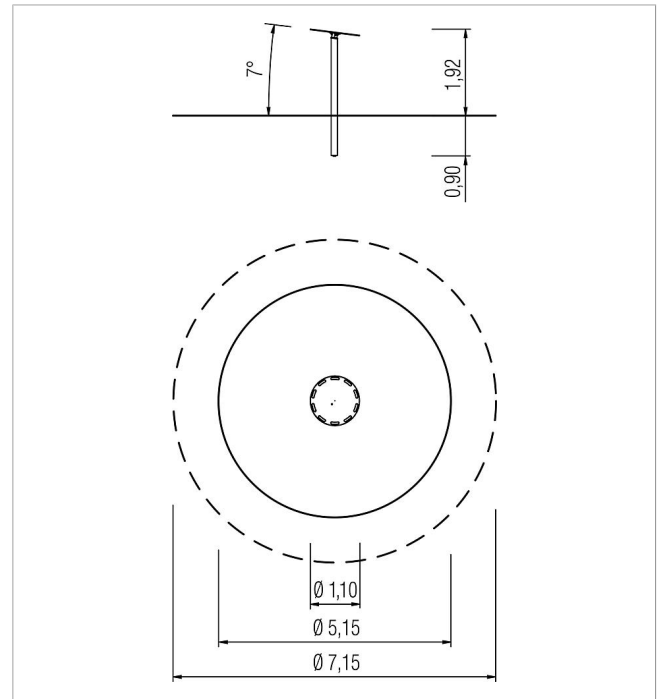

made in germany



### Scope of delivery

- 1x centre posts: steel hot-dip galvanised
- 1x rotating disk with grip: HPL



	Material	Steel powder., HPL
	Foundation level	ET 900
	Minimum space	Ø 7,15x3,00 m
	Free falling height	100 cm
	Impact protection net	21,0 m <sup>2</sup>
	Foundations	1x CF
	Assembly	2 persons/6 h
	Largest section	Ø 30x280 cm
	Heaviest section	40 kg