

5 25 912 011 00

**climbo climbing
combination Naomi,
solo**







made in germany

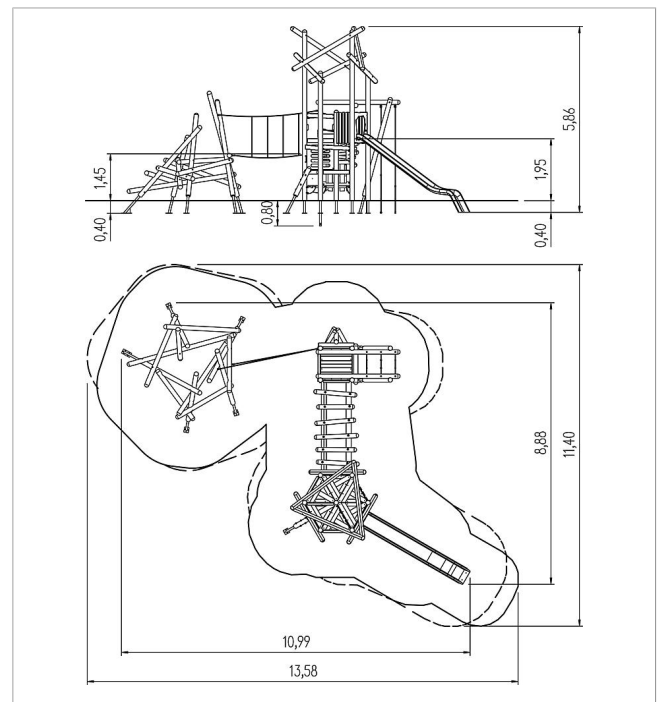

Scope of delivery

- 11x post structure: softwood or steel
- 7x platform with planks: softwood
- 1x roof crown: softwood
- 1x climbing board: high-pressure laminate (HPL)
- 1x trunk ascent: softwood
- 1x liana ascent: plastic-coated steel cable, SW
- 1x log with crossbars ascent: softwood
- 1x log bridge: softwood
- 1x climbing structure: softwood
- 7x parapet: softwood
- 2x walk-through protection: plastic-coated steel cable, stainless steel
- 1x slide entry plate: high-pressure laminate (HPL)
- 2x access restriction: high-pressure laminate (HPL)
- 3x set of grips: steel
- 2x seat bench: softwood, high-pressure laminate



	Material	SW pi
	Foundation level	ET 400/ET 700
	Minimum space	13,43x11,32x5,49 m
	Free falling height	195 cm
	Impact protection net	78,5 m ²
	Foundations	21x CF or 6x PFI + 11x PFs + 2x CF
	Assembly	2 Personen/14 Std.