

5 55 305 5

balance balancing rail Mambo







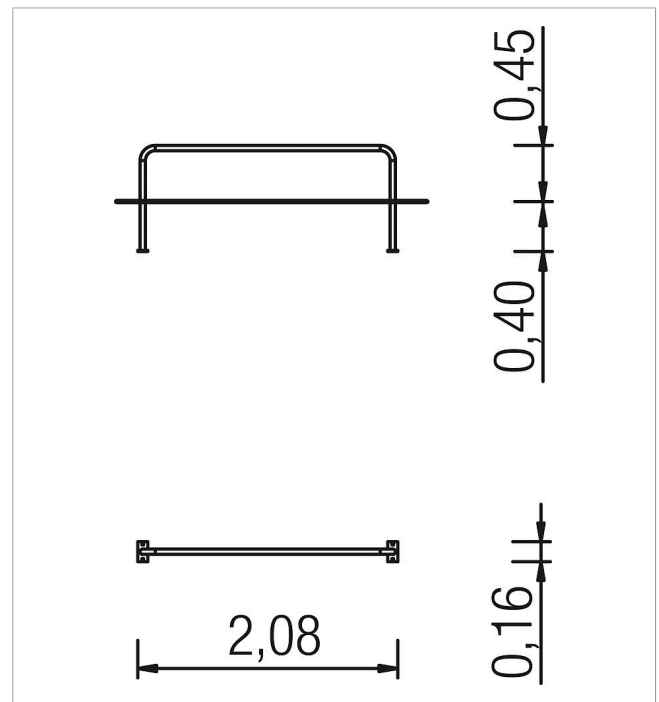

made in germany



Scope of delivery

1x balancing beam: stainless steel



	Material	Stainless steel
	Foundation level	ET 400
	Minimum space	5,04x3,04x2,25 m
	Free falling height	45 cm
	Impact protection net	-
	Foundations	2x CF
	Assembly	1 person/1 h
	Largest section	200x85 cm
	Heaviest section	10 kg