

5 55 275 024

unique aerial cable way Fjall 20 m







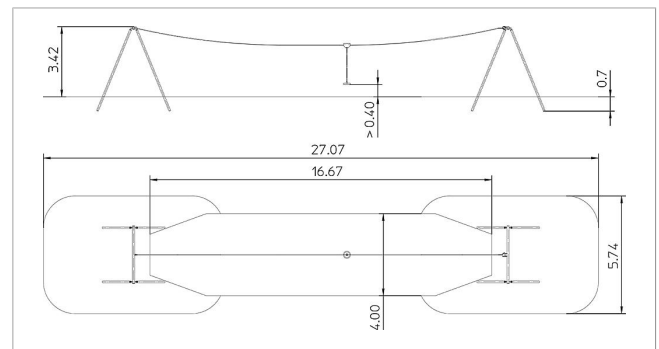

made in germany



Scope of delivery

- 1x rope anchor: galvanised steel
- 1x rope tensioning device: galvanised steel
- 1x cableway cart: stainless steel
- 1x carrying rope L 20 m: steel cable
- 2x impact spring: spring steel
- 1x swing seat: rubber
- base structure: galvanised and powder-coated steel



| | | |
|---|-----------------------|---------------------|
|  | Material | Steel powder. blue |
|  | Foundation level | ET 800 |
|  | Minimum space | 24,05x4,00x3,87 m |
|  | Free falling height | 80 cm |
|  | Impact protection net | 72,0 m ² |
|  | Foundations | 8x CF |
|  | Assembly | 2 persons/5 h |
|  | Largest section | Ø 9x450 cm |
|  | Heaviest section | 60 kg |