

5 55 194 011 00

**unique stand-up
seesaw**

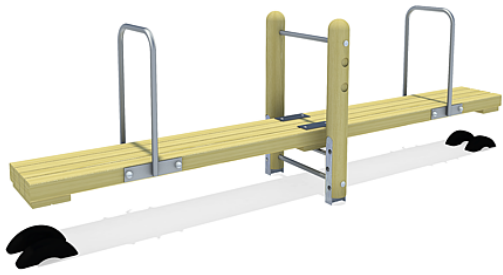





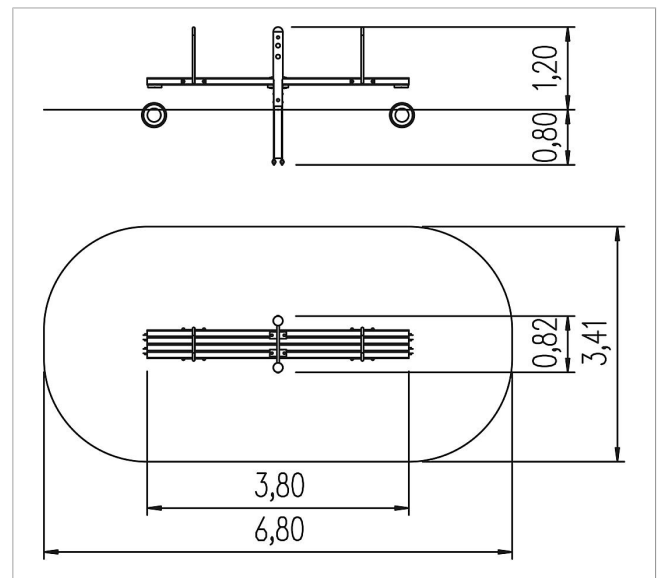

made in germany



Scope of delivery

1x see-saw beam: softwood
2x standing posts: softwood
2x grab handle: steel powder-coated
4x tyres: rubber
post bases: steel galvanised
bearing: brass



	Material	SW pi
	Foundation level	ET 800
	Minimum space	6,80x3,41x2,52 m
	Free falling height	72 cm
	Impact protection net	21,5 m ²
	Foundations	1x CF
	Assembly	2 persons/2 h
	Largest section	380x50x14 cm
	Heaviest section	70 kg