

sand and mud play unit Felix

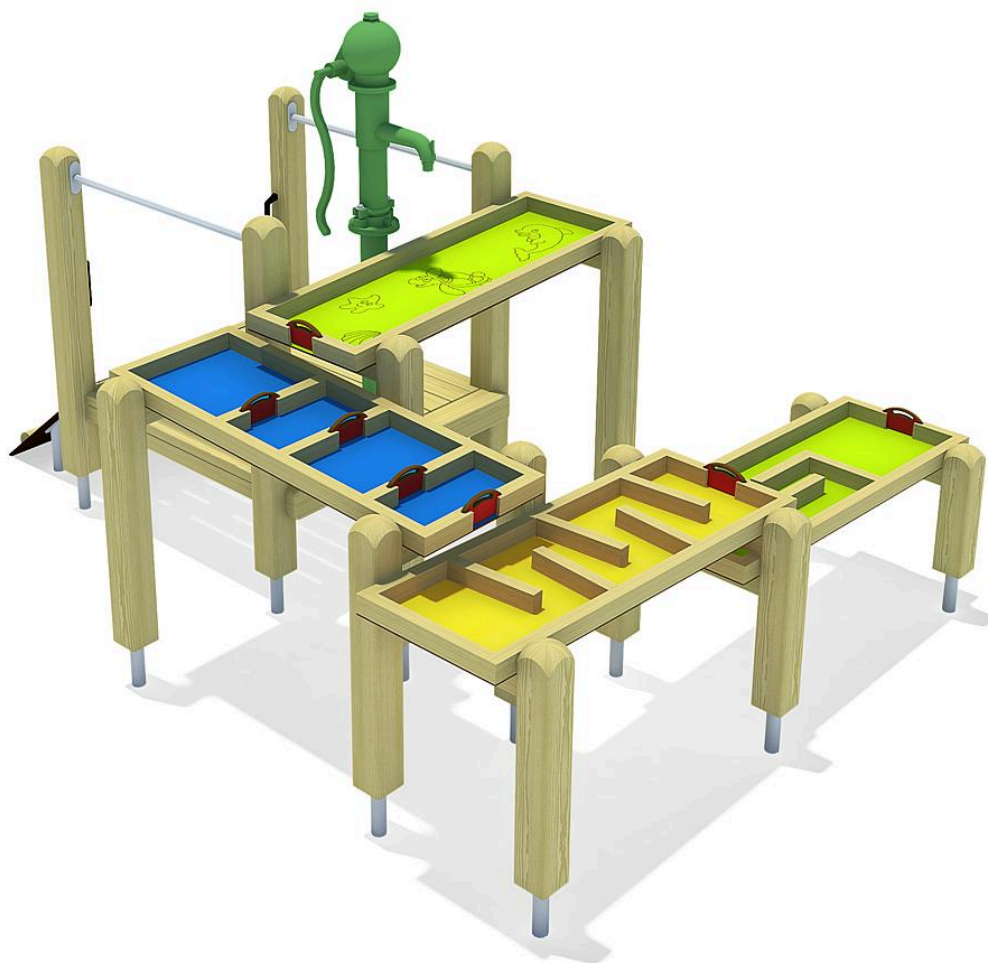

Age indication



Creativity



Living together



Experiencing the elements



Social skills



Recreation

Scope of delivery



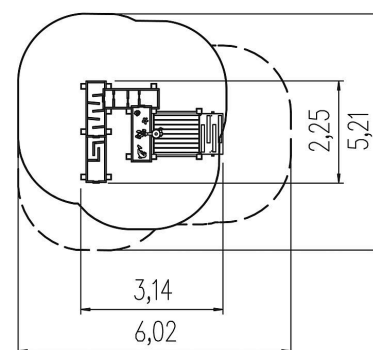
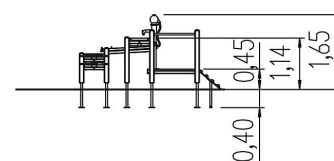





14x post construction: SW
 14x post shoe: steel galvanised
 1x platform construction: SW
 1x adapter: SW
 4x aqua path: HPL, SW
 2x walk-through protection leaf: stainless steel
 1x set of grips: aluminium, plastic coated
 1x ramp: HPL, SW
 fittings: stainless steel
 designed for the supervised area













sand and mud play unit Felix



Technical data

	Material	SW pi
	Minimum space	6,03x5,24x2,94 m
	Impact protection net	18,5 m ²
	Free falling height	114 cm
	Ground constitution DE/NL/BE	at least lawn
	Ground constitution all except DE/NL/BE	at least sand
	mx. number of users	15
	Certificate	Z2_010651_0526_Rev00
	Tested according to standard	EN 1176 - 1/7

Installation information

	Foundations	16x CF or 11x PFs
	Fundamentlevel	ET 400
	Assembly	2 persons/5 h
	PF Accessories	11x 5632540
	PF drainage	-
	PF concrete	-
	PF excavation	1,03 m ³
	CF drainage	-
	CF concrete	0,77 m ³
	CF excavation	1,79 m ³



5 11 030 011 10

sand and mud play unit Felix



CO₂ emissions of the product

676,8 kg

Material share of renewable raw materials

66%

Recyclate content

22%

Circularity score



Weighted emission factor of the product*



Disclaimer:

This dashboard for the circularity index of the 'Circular Product' certification was generated automatically and is based on the corresponding certification of eibe Produktion + Vertrieb GmbH & Co KG, Industriestraße 1, 97285 Röttingen, which was issued on 16 May 2024 by the Gesellschaft für Klimaschutz München GmbH (GKM GmbH) on the basis of the example product Albion play unit from the eibe unique® product line. eibe Produktion + Vertrieb GmbH & Co KG is liable for the accuracy of the contents. The award criteria of the private-law certification 'Circular Product' of GKM GmbH can be viewed at gesellschaft-klimaschutz.de/zertifizierung/zirkularitaet/.

* The CO₂e emissions of the materials used in the product are taken into account. The emissions that arise during the production process are allocated to the product on a pro-rata basis.

created on: 14 August 2024