

5 56 083 0







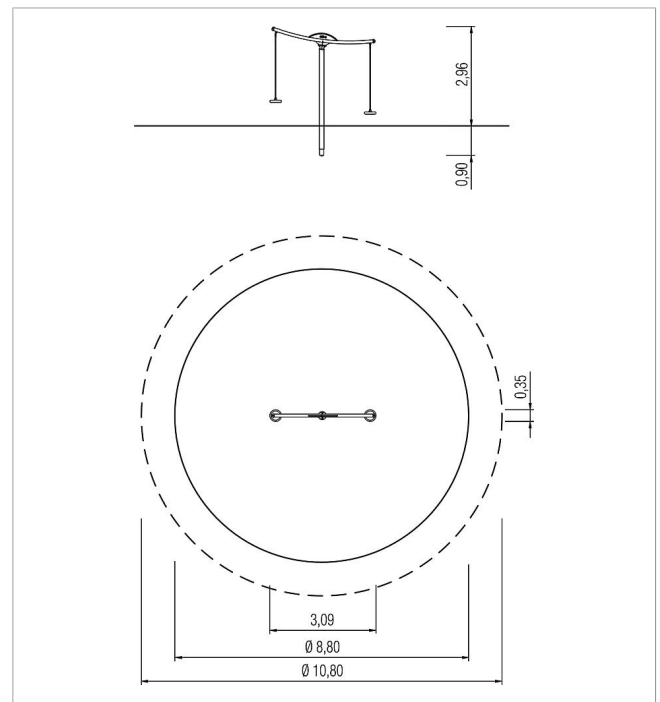

**Basis Pendulum
carousel Hyperion Ø
3,10 m**
made in germany



Scope of delivery

- 1x post Ø 13,9 cm: steel hot-dip galvanised
- 1x crossbeams Ø 8,9 cm: steel hot-dip galvanised
- 2x pendulum seat with chain: rubber, stainless steel (VA)



	Material	powdered steel, rubber
	Foundation level	ET 900
	Minimum space	Ø 10,80x3,28 m
	Free falling height	105 cm
	Impact protection net	61,0 m ²
	Foundations	1x CF
	Assembly	2 persons/6 h
	Largest section	330x30x30 cm
	Heaviest section	50 kg