

5 40 101 111 31

## Basis Attachment slide, PH 145 cm







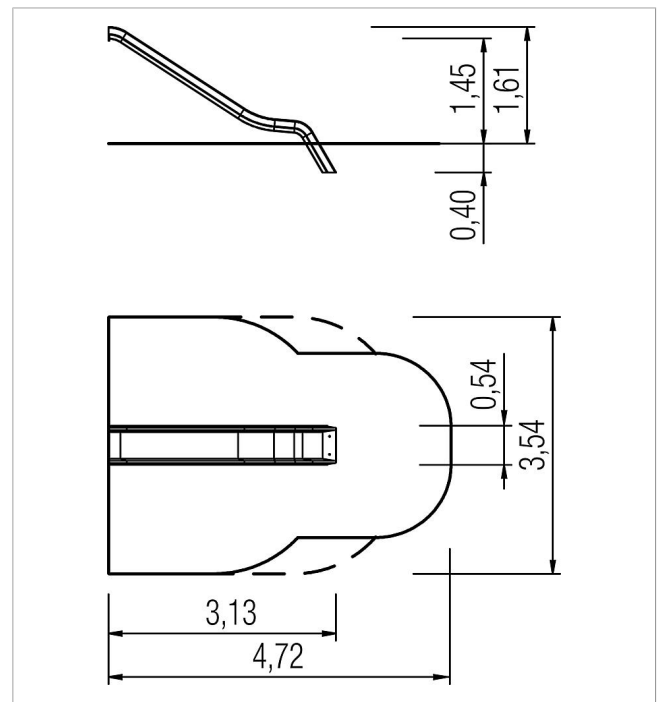

made in germany



### Scope of delivery

1x slide PH 145 cm: GFRP with stainless steel cover



	Material	GFRP iguana with stainless steel coating
	Foundation level	FL 1
	Minimum space	4,56x3,52x3,25 m
	Free falling height	145 cm
	Impact protection net	15,0 m <sup>2</sup>
	Foundations	1x CF or 1x PFs
	Assembly	2 persons/1 h
	Largest section	375x48x45 cm
	Heaviest section	55 kg